

GARY'S
GARDEN SHEDS

SERIOUSLY **STRONG** **SHEDS**

DESIGNED & BUILT RIGHT FOR YOU





At Gary's Garden Sheds we pride ourselves in delivering superior quality sheds with professional installation.

Designed to withstand New Zealand's harsh conditions, all our sheds use the latest product from New Zealand Steel - COLORSTEEL® MAXAM™, with Activate Technology – designed to deliver enhanced corrosion resistance giving the confidence your shed will stand the test of time.

We encourage our customers to visit our showroom and inspect our sheds as the quality speaks for itself.

We're all kiwi

At Gary's Garden Sheds we are proud to be NZ owned, producing NZ made products with locally sourced materials.

We're specialists

Gary's Garden Sheds is a NZ owned family business with over 30 years experience specialising in garden shed design and installation.

Our sheds are custom made

Every shed we build is custom made to your specifications, allowing you to get exactly what you want. We guide you through choosing the colours, window and door placement, roof types and other optional extras if required.

Installation is included

We aim to make purchasing a shed as easy and stress free as possible, so we look after you through the whole process. Once we have the right design for your site our experienced shed builders will take care of the installation, all included – easy.

Warranty

Our sheds are built to last using premium New Zealand sourced materials and a proven design. We proudly offer the COLORSTEEL® MAXAM™ warranty of up to 50 years on our cladding, reflecting its exceptional durability. For specific details on this and other warranty components please ask our team.



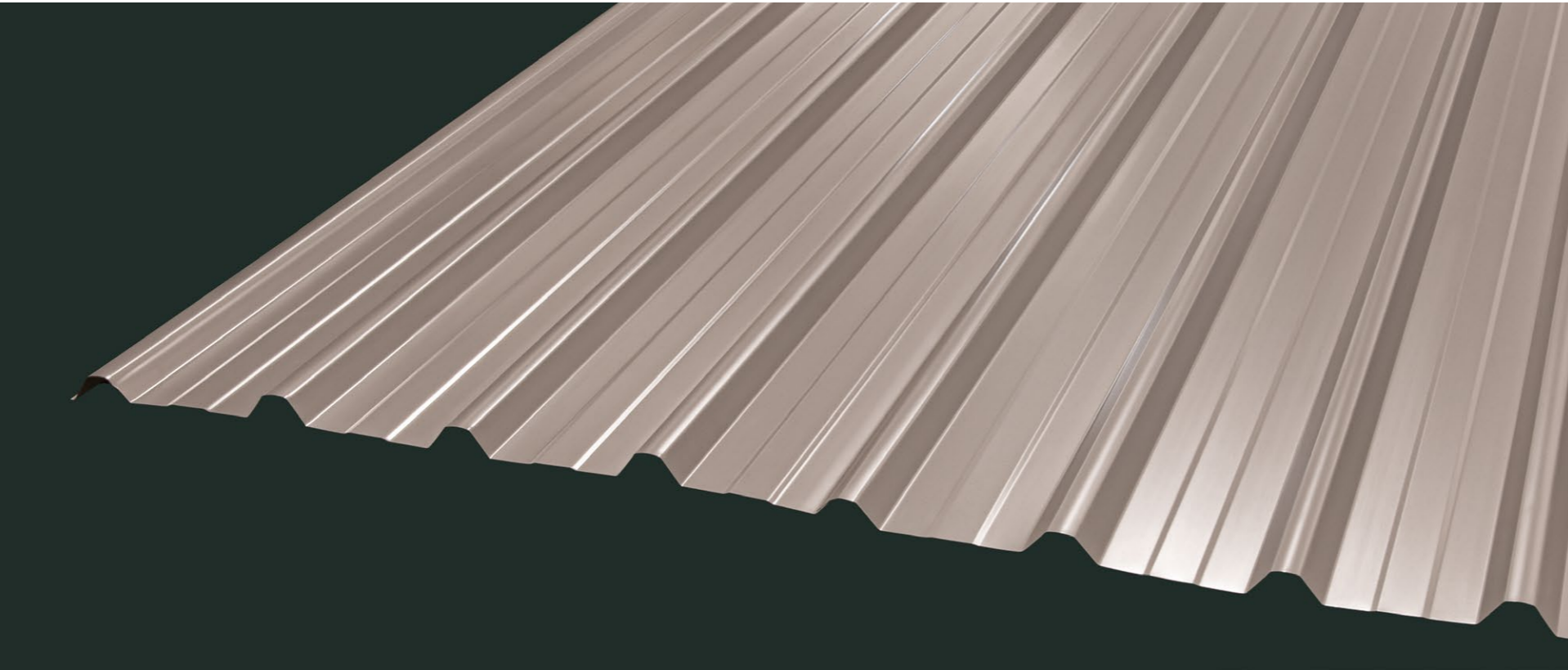

Our sheds are built with the latest product from NZ Steel, COLORSTEEL® MAXAM™ with Activate technology. Made, tested and trusted for New Zealand conditions.

Gary's Garden Sheds are constructed with roofing quality COLORSTEEL® MAXAM™ 0.4mm high tensile steel for extra strength and durability. **This means that every Gary's Garden Shed is constructed with Coastal Grade materials as standard.**

The profile we use is trapezoidal with crisp clean lines, providing a high strength to weight ratio. It's perfect for creating good looking premium sheds that will stand the test of time.

COLORSTEEL® MAXAM™ comes in a wide range of colours to suit your style, and you can mix and match trims to create the shed of your dreams.

Enhanced corrosion resistance: The patented AM metallic coating with ACTIVATE™ technology provides greater durability. MAXAM™ is a single solution, suitable whether your property is on the coast, inland or an industrial environment.

Extended warranties: Up to 50 years of warranty coverage for corrosion to perforation, ensures long-term peace of mind.

Versatility: Suitable for almost all New Zealand environments, offering a hassle-free choice for any project location.

COLORSTEEL® MAXAM™, the next generation of COLORSTEEL®, taking durability and corrosion resistance to the next level. Along with your shed!



Small Sheds

Small sheds are a great solution for adding storage in a limited space. With the same quality and features as our larger models there's no need to compromise. You can customise the size and height of your shed to perfectly fit your space and needs. We have a range of options to help turn those tight or unused spots into valuable storage space.

Door options:
Sliding or hinged

Roofline:
Lean-to

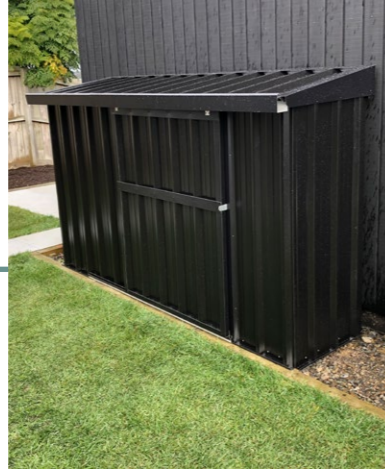

Medium Sheds

Medium sheds are a great solution for added storage or sheltered space. With superior strength and quality fixtures, you can rest assured that our medium sheds will stand against harsh NZ conditions.

Door options:
Sliding or hinged

Roofline:
Lean-to or Gable



Large & XL Sheds

Our large sheds are great for storage, workshops or sleepouts, making them our most popular range. With endless opportunities and a variety of options for storing bikes, ride-on mowers, kayaks etc, our large sheds are designed and built right for you.

Door options:
Sliding or hinged
PA & Roller doors available

Roofline:
Lean-to or Gable
(Lean-to option subject to size)



Long & Narrow Sheds

Long and narrow sheds are perfect for maximizing storage down the side of the house or other narrow spaces providing the ideal storage solution where space is at a premium or you just require storage for those long pieces of equipment. Customize the length, depth and door position to create the ideal storage solution for your needs, turning those challenging spots into practical, organized spaces.

Door options:
Sliding or hinged

Roofline:
Lean-to (Gable option subject to size)





Bike Sheds



Pool Pump Sheds



Commercial Equipment Sheds

We manufacture a range of storage solutions for both residential and commercial sites



Carpark Storage Units



Roller Door



Studios



Wood Sheds



Ride-On Storage



Club Shelters



Vents

Why choose a Gary's Garden Shed?

Strength

High tensile steel. We use NZ COLORSTEEL® MAXAM™ 0.4mm or 0.55mm for extra strength and durability.

Strong profile steel. 30mm T-Rib cladding for superior strength

Strong foundation. Purpose built H4 4x2 base is standard providing a strong foundation for the shed.

Heavy gauge channels. Folded channels for strength and durability.

High wind tolerance. Suitable for very high wind zones.

Quality

NZ sourced materials ensuring high quality and local support.

Built with genuine COLORSTEEL® Ideal for NZ's harsh conditions.

Treated H4 timber base & H3 floor for longevity.

Weathertightness

Guttering provides easy water run off.

No corner joins. We wrap the steel around the corners for added protection and strength.

Cladding drops 45mm below the floorline to ensure the best protection from water seepage.

Convenience

Installation is included. Our sheds are professionally constructed by our team of experienced shed builders to ensure quality and durability.

Padlock ready. All sheds are padlock ready (not supplied)

No council consents required.

Extensive colour range. Choose from a wide range of COLORSTEEL® options.

Space saving doors. Doors slide on the outside of shed to allow more storage inside.

Low maintenance: COLORSTEEL® MAXAM™ provides the convenience of low maintenance without sacrificing style.

Our sheds come with all of these features as standard making every Gary's Garden Shed a premium quality product that is built to last.



H4 treated timber subfloor



18mm Plywood Flooring



Standard installation



Sloped installation



No floor

Base, Flooring and Roofing

Your shed can be built directly onto lawn, concrete, or decking. Our professional installers ensure your shed base and floor is secured and level on your site using H4 treated timber and H3 18mm plywood flooring. To ensure the shed stays weathertight, the COLORSTEEL® cladding extends below the plywood floor level, secured within a steel channel that wraps around the base of the shed. Water flows easily away from the channel ends. The timber base offers flexibility for future relocation of the shed if needed.

Preparation required

No preparation is required other than providing us with a cleared site which can save you time and money. The highest point of your site will be the base level so discuss with our team your options if you would like your shed to sit lower.

Standard - Flat site

We rarely come across a perfectly flat site so we allow for a slight fall on your site. If you're unsure if your site would be considered sloped, please send us photos so we can advise if further investigation is needed.

Sloped

Our team can find a solution for your sloped site. We have a surcharge for installing on a sloped site for the additional work, for extreme sites we may require the posts to be concreted. Talk to us if you are unsure if your site is considered sloped.

No Floor

We can build sheds without a floor if you have a suitable base or platform. When opting for no floor, it's essential that we have a flat, level site for installation - level decks and concrete pads are ideal. If you're constructing your own base please consult with us about sizing and levels beforehand to ensure a perfect fit with our shed and a smooth installation.

The Gable Roof

Gable sheds can be built with the gable facing the front or the side depending on the size of the shed. Gables are available on our medium to large sheds and have the gutters running along both low sides.



The Lean-To Roof

The Lean-to roof slopes towards the back and have a gutter running along the low side at the back. Lean-to styles are available on small to large sheds up to a maximum depth of 2.4m.



The Reverse Lean-To Roof

The Reverse Lean-to option allows the water to run towards the front - useful if wanting to direct the water flow away from the house.



Heights

Our standard external height of our sheds with a floor is 2100mm (high point). If you need extra headroom, we can increase the height up to an additional 400mm. Alternatively, if a lower height better fits your site, then we can accommodate that as well. Just reach out to our team to find the perfect height for your needs. Please note due to the manufacturing process, heights and sizes can vary slightly so if space is a concern please talk to our team.

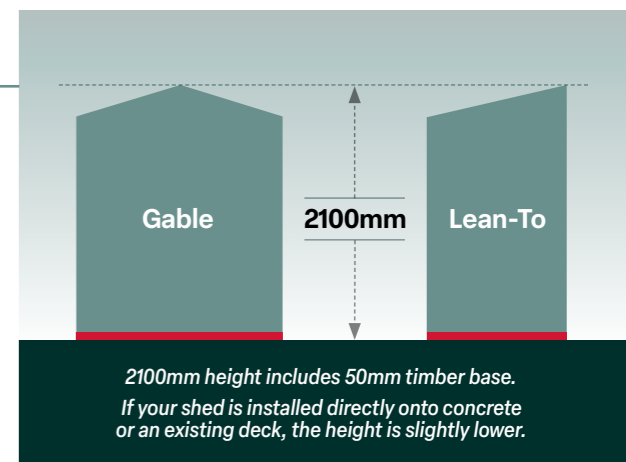



Sliding Doors



Hinged Doors



PA Door

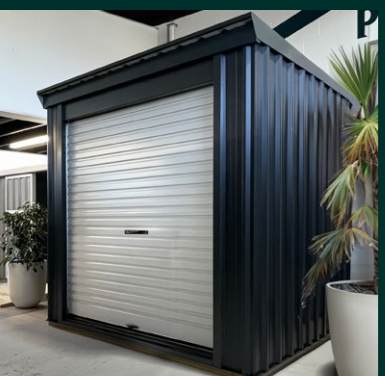

Roller Doors



Locks

Doors

Our custom design allows for door access to be positioned on any wall, depending on size and type.

Sliding Doors

Our sliding doors slide conveniently on the outside of the shed allowing use of the inside wall for storage. They feature both top and bottom tracks manufactured with a thicker gauge of steel to ensure they stay on track and glide smoothly with a high quality rollers.

Available in single or double door options for a wider entry and in 3 sizes to find that perfect fit. Add Glass Panels for additional light.

Hinged Doors

Our hinged doors are strong with full bracing making them the perfect upgrade to maximise access. Small or narrow sheds, tight spots requiring side access or large sheds needing wide entries for larger equipment or ride ons. Hinged doors offer added security and come with a slide bolt for locking (padlock not supplied).

Available in single or double door options for a wider entry and in 3 sizes to find that perfect fit.

Personal Access Door (PA Door)

A PA door can be added for convenient & secure access. Made from high quality, heavy duty NZ steel.

Roller Doors

Roller doors provide maximum opening height for your shed. Only available on limited size range, speak to our team about these options.

Locks

All sheds come ready to fit with a padlock (not supplied). We have a range of padlocks available to purchase.

Optional Extras

To get the most out of your shed choose from our range of optional extras. We are more than happy to discuss the range and work out the best options that suit your needs. As your shed is custom made we have the flexibility to place doors, windows, etc. to suit your site requirements.



Louvre window allows natural light and airflow.



Fixed glass window for added natural light.



Clearlite roof panel for added natural light.



Paper and netting* for extra protection from moisture and condensation.

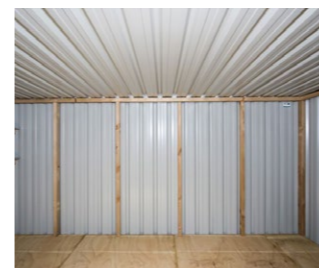

Timber framing gives customers a base to attach shelves, hooks, nails etc.



Plywood tool board to organise all those precious tools.



MDF shelves to maximise storage space.*



Framed workbench.*
**Requires timber framing*

Also available

- Gutter options for water diversion and collection
- Extra height
- Base framing

Talk to us about your needs.



Colours

We stock the full range of COLORSTEEL® MAXAM™ inspired by the ever-changing landscape of Aotearoa, New Zealand. Giving you the opportunity to make a choice that works with your surroundings and reflects your style. COLORSTEEL® MAXAM™ with Activate Technology is suitable for most of New Zealand's environmental conditions providing exceptional durability and corrosion protection. With Gary's Garden Sheds you are choosing with confidence a genuine COLORSTEEL® product.

COLORSTEEL® MAXAM™ takes durability and corrosion resistance to the next level and with convenience of low maintenance it's the perfect blend of form and function.

Our sheds come in either two toned or all-in-one colours. Choose the cladding from the full range of COLORSTEEL® MAXAM™ colours (listed on opposite page). Next choose a trim colour to suit – please note trim colours are subject to availability please speak to us about current available options. We are happy to help recommend a colour to match your chosen cladding.

Selecting your colours:



- 1 Choose your cladding colour.
- 2 Choose your roof colour.
- 3 Choose your trim colour or opt for all-in-one.

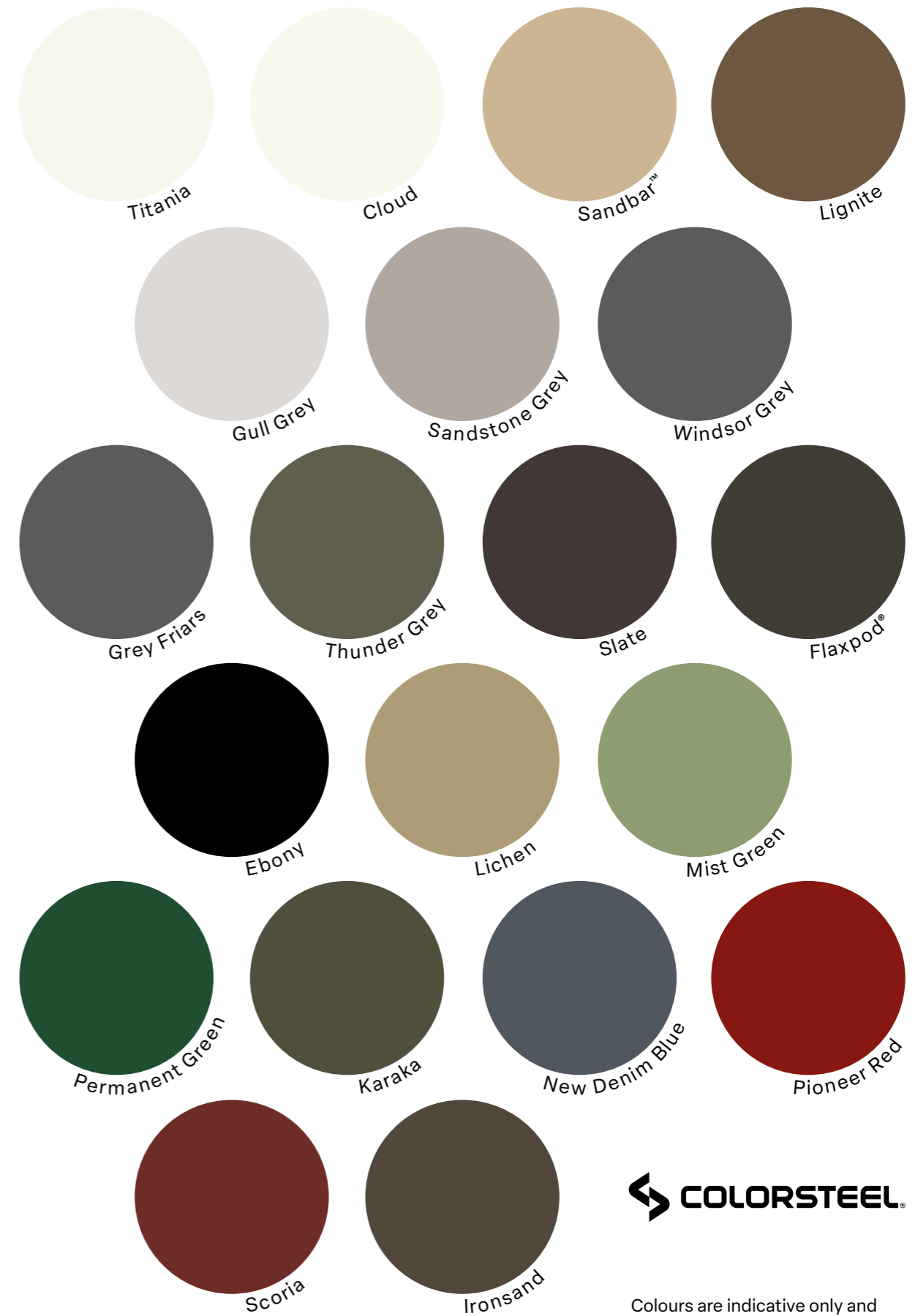

Colours are indicative only and we recommend viewing actual COLORSTEEL® samples before making a final decision. Physical samples are available from our showrooms.

GARY'S GARDEN SHEDS

www.garysgardensheds.co.nz

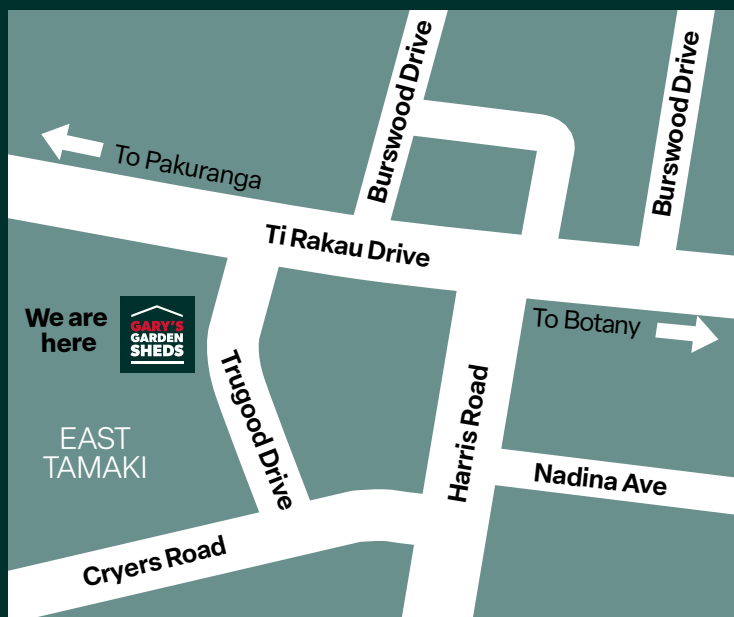

Visit our showroom at:

9b Trugood Drive, East Tamaki, Auckland

Ph: 09 274 6617 **Mobile:** 021 97 5656

Email: sales@ggs.co.nz

Open:

Monday to Friday 8.30 – 4pm

Saturday 9 – 12pm

